



VARO 80 S

track

EN Track light made of die-cast aluminium; surface powder coated; spotlight head 355° rotatable and 90° tiltable; integrated converter in the plastic adapter; high quality reflector with spherical facet finish; precise radiation characteristics with different beam angles; installed and exchanged without tools; optical attachments as accessories; optical attachments can be combined; COB (Chip on Board) technology for maximum efficiency; variants with > 120 lm/W available; no multiple shadows; energy-efficient LEDs with very good colour rendering; adapter for toolless insertion or movement on a variety of 3-phase power tracks

FR Spot sur rail en fonte d'aluminium injectée ; surface thermolaquée ; tête de spot rotatif à 355° et orientable à 90° ; convertisseur intégré à l'adaptateur plastique ; réflecteur de grande qualité avec optique facette sphérique ; précision de caractéristique de rayonnement avec divers angles de diffusion ; Installation resp. remplacement sans outil ; éléments optiques comme accessoires ; les accessoires optiques peuvent être combinés entre eux ; avec technologie COB (Chip on Board) pour efficacité maximale ; variantes disponibles avec > 120 lm/W ; pas de formation d'ombres multiples ; LED économes en énergie à restitution de couleur élevée ; adaptateur pour installation ou déplacement sans outil dans différents rails trip hasés

Quickinfo

3000K, 3500K, 4000K
CRI ≥ 90, 3 SDCM
up to 148 lm/W
L95 / 50 000h
non DIM, DALI-2

Type

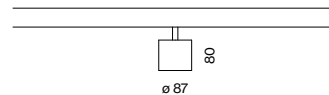

Colours



Light distributions



spot med. flood



up to 148 lm/W
(high efficiency)



355° rotatable
90° tiltable

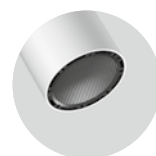

optical
accessories



combine 2 optical
accessories

Order options

COLOUR TEMPERATURE

3000K	0
3500K	2
4000K	1

CONTROL

non DIM	1
DALI-2	3

MATERIAL COLOUR

○ traffic white RAL 9016	7
● jet black RAL 9005	8

BEAM ANGLE

spot 17°	S
medium 28°	M
flood 38°	F

Options on request

COLOUR RENDERING INDEX

CRI ≥ 80

CONTROL

Casambi

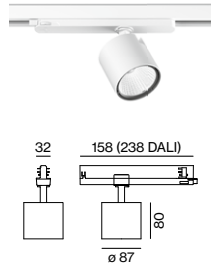

VARO 80 S track



HIGH EFFICIENCY

SYSTEM POWER	LUMINOUS FLUX	ORDER CODE
13W	1920lm	180-6424
21.1W	2800lm	180-6422
25.3W	3160lm	180-6423

Optical accessories

LENSES AND HONEYCOUMB LOUVER

TYPE	Ø-H (mm)	ORDER CODE
linear prismatic lens	75-9	080-6402110P
honeycomb louver	75-9	080-6401118

SNOOT

TYPE	Ø-H (mm)	ORDER CODE
short	66-23	080-6403118
medium	66-38	080-6403218
angle	66-38	080-6403318

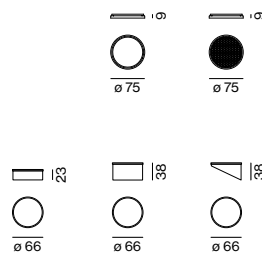

possibility to combine different optical accessories (max. 2 pieces)



Types

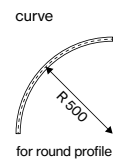
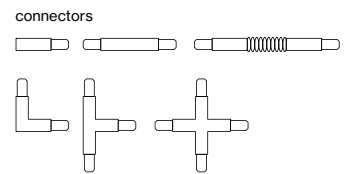
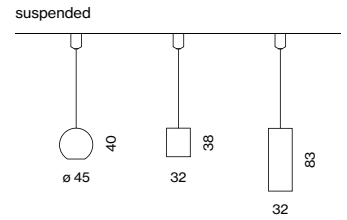
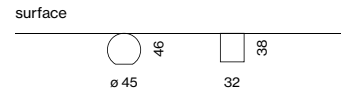
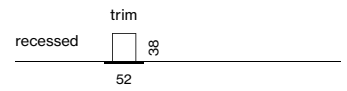

Colours



TRACK 3-phase
recessed/surface/suspended



curve connector



optimised adapter integration

TRACK recessed

Order options

CONTROL

non DIM

DALI-2

MATERIAL COLOUR

- pure white RAL 9010 7
- jet black RAL 9005 8

Pole options

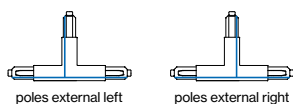
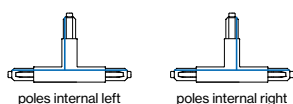

TRACK 3-phase/3-phase + DALI-2-bus



TRACK 240V-16A

L (mm)	ORDER CODE
2000	186-012213
3000	186-012313
4000	186-012413

end cap 186-022011

end feed left 186-022313
 end feed right 186-022413
 middle feed 186-021323

CONNECTORS 240V-16A

TYPE **ORDER CODE**
 linear connector 186-021113

I-connector 186-022123

L-connector right 186-022133
 L-connector left 186-022233

T-connector right (poles internal) 186-022143
 T-connector left (poles internal) 186-022243
 T-connector right (poles external) 186-022173
 T-connector left (poles external) 186-022273

X-connector 186-022153

MOUNTING ACCESSORIES

TYPE **ORDER CODE**
 clip 186-0225110
 cutting tool 186-0219110

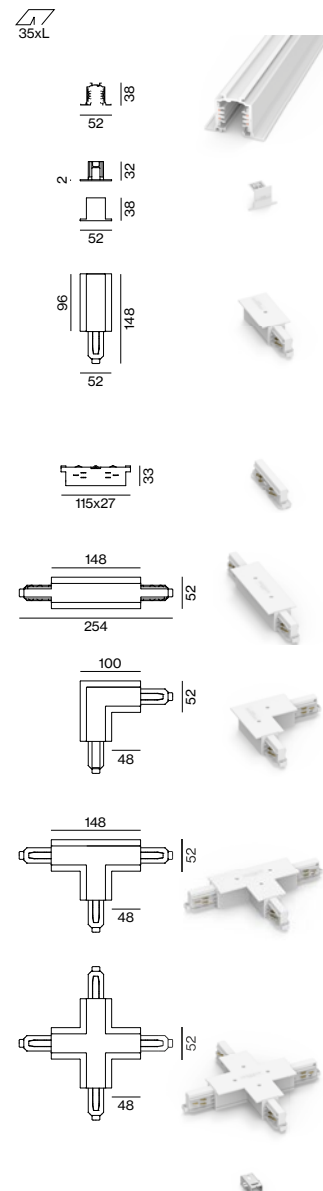

TRACK

surface/suspended

Order options

CONTROL

non DIM
 DALI-2

MATERIAL COLOUR

- pure white RAL 9010 7
- grey 6
- jet black RAL 9005 8

Pole options

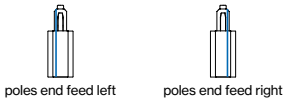
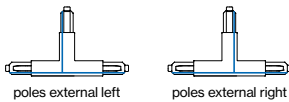
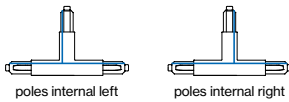

TRACK 3-phase/3-phase + DALI-2-bus



TRACK 240V-16A

L (mm)	ORDER CODE
1000	186-011123
2000	186-011223
3000	186-011323
4000	186-011423

end cap 186-021011

end feed left 186-021313
 end feed right 186-021413
 middle feed* 186-021323

*only available in white and black

CONNECTORS 240V-16A

TYPE ORDER CODE
 linear connector 186-021113

I-connector 186-021123

L-connector right 186-021133

L-connector left 186-021233

T-connector right (poles internal) 186-021143

T-connector left (poles internal) 186-021243

T-connector right (poles external) 186-021173

T-connector left (poles external) 186-021273

X-connector 186-021153

adjustable corner connector 186-021163

MOUNTING ACCESSORIES

TYPE ORDER CODE
 ceiling clip 186-021511

pendant clip cable 186-021521

pendant clip rod 186-021541

joiner piece cable 186-021531

joiner piece rod 186-021551

cutting tool 186-0219110

SUSPENSION KIT

TYPE ORDER CODE
 pendant 1000 186-021611

cable 1500 186-0217110

cable 3000 186-0217210

cable 5000 186-0217310

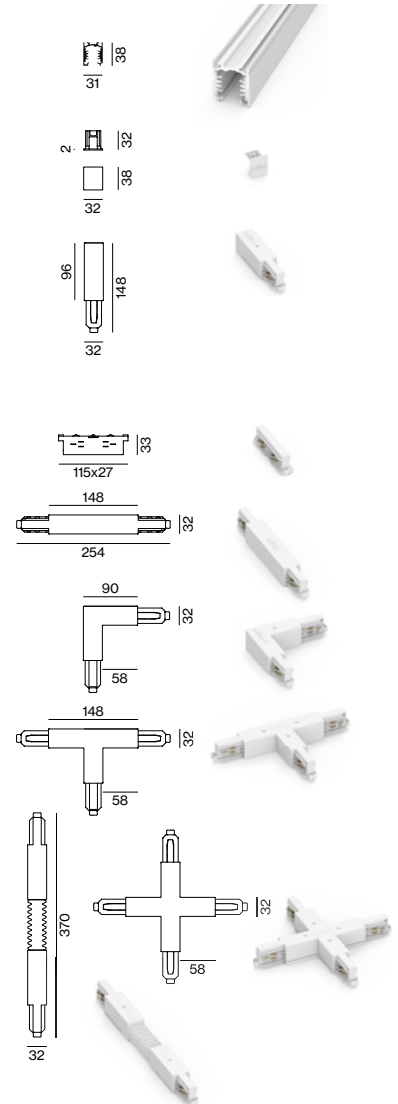

TRACK high

surface/suspended

Order options

CONTROL

non DIM

DALI-2

MATERIAL COLOUR

○ pure white RAL 9010 7

● jet black RAL 9005 8

Options on request

LIGHT OPTIC COVER

inset indirect

Pole options

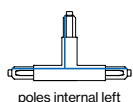

poles internal left

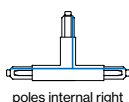

poles internal right

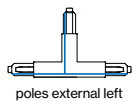

poles external left

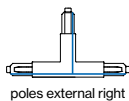

poles external right



poles end feed left



poles end feed right

TRACK high 3-phase/3-phase + DALI-2-bus



TRACK 240V-16A

L (mm)	ORDER CODE
1000	186-016113
2000	186-016213
3000	186-016313
4000	186-016413

end cap 186-026011

end feed left 186-026313

end feed right 186-026413

middle feed 186-021323

CONNECTORS 240V-16A

TYPE ORDER CODE
linear connector 186-026113

I-connector 186-026123

L-connector right 186-026133

L-connector left 186-026233

T-connector right (poles internal) 186-026143

T-connector left (poles internal) 186-026243

T-connector right (poles external) 186-026173

T-connector left (poles external) 186-026273

X-connector 186-026153

MOUNTING ACCESSORIES

TYPE ORDER CODE
pendant clip cable 186-0265210
pendant sheet metal clip 186-0215220
pendant clip rod 186-0265410

joiner piece cable 186-0265310

joiner piece rod 186-0265510

cutting tool 186-0219110

SUSPENSION KIT

TYPE ORDER CODE
pendant 1000 186-0216110

cable 1500 186-0217110

cable 3000 186-0217210

cable 5000 186-0217310

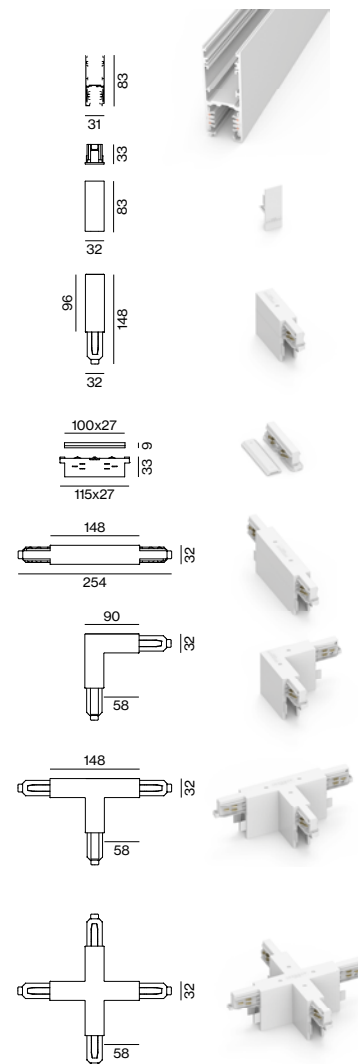

TRACK round surface/suspended

Order options

CONTROL

non DIM

DALI-2

MATERIAL COLOUR

- pure white RAL 9010 7
- jet black RAL 9005 8

Pole options

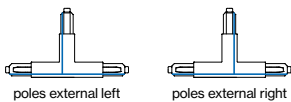
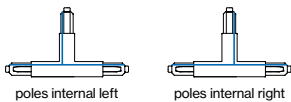

TRACK round 3-phase/3-phase + DALI-2-bus



TRACK 240V-16A

L (mm)	ORDER CODE
1000	186-015113
2000	186-015213
3000	186-015313
4000	186-015413

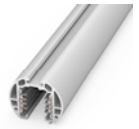

TRACK CURVE 240V-16A

TYPE	ORDER CODE
R 500 90° left	186-015853
R 500 90° right	186-015863

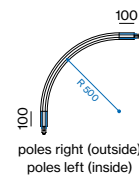

poles right (outside)
poles left (inside)



end cap 186-025011



end feed left 186-025313
end feed right 186-025413
middle feed 186-021323

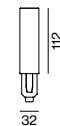

CONNECTORS 240V-16A

linear connector 186-021113

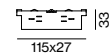

L-connector right (external) 186-025133

L-connector left (internal) 186-025233

T-connector left (poles external) 186-025243

T-connector right (poles external) 186-025143

T-connector right (poles internal) 186-025273

T-connector left (poles internal) 186-025173

X-connector 186-025153

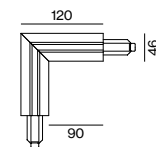

MOUNTING ACCESSORIES

pendant clip cable 186-025521
pendant clip rod 186-025541

joiner piece cable 186-025531

joiner piece rod 186-025551

cutting tool 186-0279110

SUSPENSION KIT

pendant 1000 186-021611

cable 1500 186-0217110

cable 3000 186-0217210

cable 5000 186-0217310