



BO 55/70

track

EN Track light made of die-cast aluminium; surface powder coated; spotlight head 355° rotatable and 90° tiltable; converter integrated in the power track adapter; high-quality, aluminium, vapour deposition coated reflector with faceted design; precise radiation characteristics with different beam angles; good glare reduction due to recessed light point plane; optical attachments as accessories; COB (Chip on Board) technology for maximum efficiency; no multiple shadows; energy-efficient LEDs with very good colour rendering; adapter for toolless insertion or movement on a variety of 3-phase power tracks

ES Foco de carril electrificado de fundición de aluminio; recubrimiento de pintura en polvo; cabezal giratorio a 355° y orientable a 90°; convertidor integrado en el adaptador de carril; reflector de alta calidad de aluminio vaporizado con óptica facetada; proyección precisa con distintos ángulos de apertura; buen control del deslumbramiento por plano de punto de luz retranqueado; elementos ópticos accesorios; con tecnología COB (Chip on Board) para la máxima eficiencia; sin sombras múltiples; LEDs de alta eficiencia con muy buena reproducción cromática; adaptador para instalación sin herramienta o desplazamiento en diferentes carriles trifásicos

Quickinfo

3000K, 3500K, 4000K
CRI ≥ 90 2-SDCM
up to 87lm/W
L80 @ 50000h
non DIM, DALI-2

Types

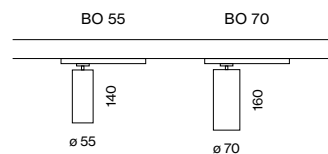

Colours



Light distributions

BO 55



spot med. flood

BO 70



spot med. flood wide flood



glare control via
honeycomb louver



355° rotatable,
90° tiltable

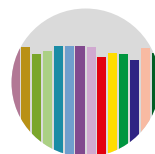

CRI ≥ 90,
2 SDCM

Order options

COLOUR TEMPERATURE

3000K	5
3500K	7
4000K	6

CONTROL

non DIM	1
DALI-2	3

MATERIAL COLOUR

○ traffic white RAL 9016	7
● jet black RAL 9005	8

BEAM ANGLE BO 55

spot 17°	S
medium 24°	M
flood 40°	F

BEAM ANGLE BO 70

spot 15°	S
medium 23°	M
flood 37°	F
wide flood 57°	W

Options on request

COLOUR RENDERING INDEX

CRI ≥ 95, 2 SDCM

CONTROL

Casambi

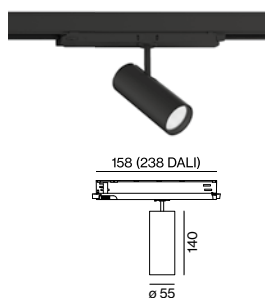

BO 55 track



TRACK LIGHT

SYSTEM POWER	LUMINOUS FLUX	ORDER CODE
24.8W	2150lm	180-7312

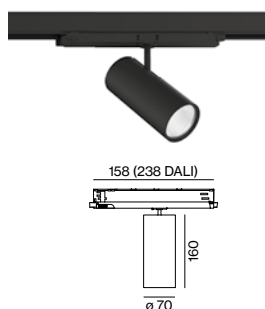

BO 70 track



TRACK LIGHT

SYSTEM POWER	LUMINOUS FLUX	ORDER CODE
40W	3410lm	180-7411

Optical accessories

HONEYCOMB LOUVER

TYPE	Ø-H (mm)	ORDER CODE
BO 55	50.3	007-196598
BO 70	61.3	080-5900018

OVAL LENS

TYPE	Ø-H (mm)	ORDER CODE
BO 55	50.3	007-1965890

SOFT LENS

TYPE	Ø-H (mm)	ORDER CODE
BO 55	50.3	007-1965990

WALLWASHER LENS

TYPE	Ø-H (mm)	ORDER CODE
BO 55	50.3	007-1965790

LUMINOUS FLUX value calculated for
3000K/3500K, CRI ≥ 90, colour white, flood
4000K +5%



Types

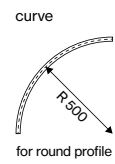
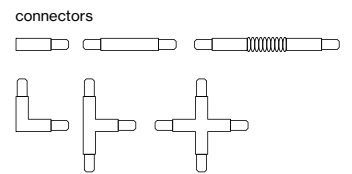
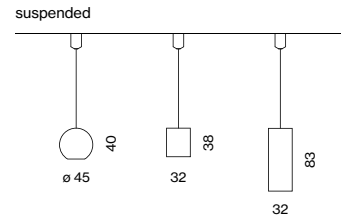
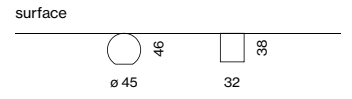
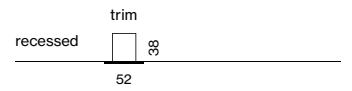

Colours



TRACK 3-phase
recessed/surface/suspended



curve connector



optimised adapter integration

TRACK recessed

Order options

CONTROL

non DIM

DALI-2

MATERIAL COLOUR

- pure white RAL 9010 7
- jet black RAL 9005 8

Pole options

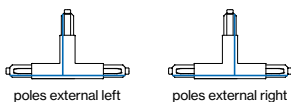
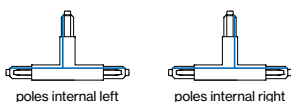

TRACK 3-phase/3-phase + DALI-2-bus



TRACK 240V-16A

L (mm)	ORDER CODE
2000	186-012213
3000	186-012313
4000	186-012413

end cap 186-022011

end feed left 186-022313
 end feed right 186-022413
 middle feed 186-021323

CONNECTORS 240V-16A

TYPE **ORDER CODE**
 linear connector 186-021113

I-connector 186-022123

L-connector right 186-022133
 L-connector left 186-022233

T-connector right (poles internal) 186-022143
 T-connector left (poles internal) 186-022243
 T-connector right (poles external) 186-022173
 T-connector left (poles external) 186-022273

X-connector 186-022153

MOUNTING ACCESSORIES

TYPE **ORDER CODE**
 clip 186-022511
 cutting tool 186-021911

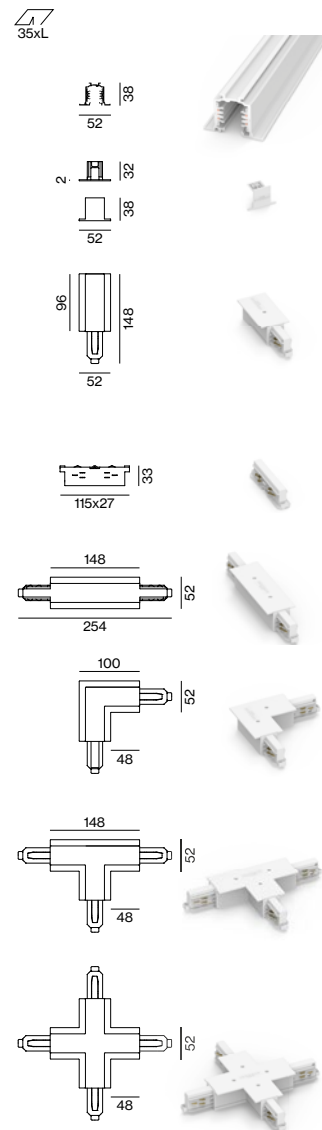

TRACK

surface/suspended

Order options

CONTROL

non DIM
 DALI-2

MATERIAL COLOUR

- pure white RAL 9010 7
- grey 6
- jet black RAL 9005 8

Pole options

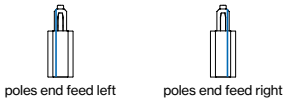
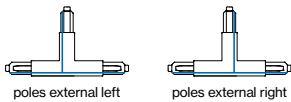
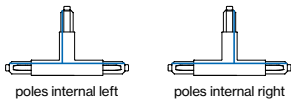

TRACK 3-phase/3-phase + DALI-2-bus



TRACK 240V-16A

L (mm)	ORDER CODE
1000	186-011123
2000	186-011223
3000	186-011323
4000	186-011423

end cap 186-021011

end feed left 186-021313
 end feed right 186-021413
 middle feed* 186-021323

*only available in white and black

CONNECTORS 240V-16A

TYPE ORDER CODE
 linear connector 186-021113

I-connector 186-021123

L-connector right 186-021133
 L-connector left 186-021233

T-connector right (poles internal) 186-021143
 T-connector left (poles internal) 186-021243
 T-connector right (poles external) 186-021173
 T-connector left (poles external) 186-021273

X-connector 186-021153

adjustable corner connector 186-021163

MOUNTING ACCESSORIES

TYPE ORDER CODE
 ceiling clip 186-021511

pendant clip cable 186-021521
 pendant clip rod 186-021541

joiner piece cable 186-021531
 joiner piece rod 186-021551

cutting tool 186-0219110

SUSPENSION KIT

TYPE ORDER CODE
 pendant 1000 186-021611

cable 1500 186-0217110
 cable 3000 186-0217210
 cable 5000 186-0217310

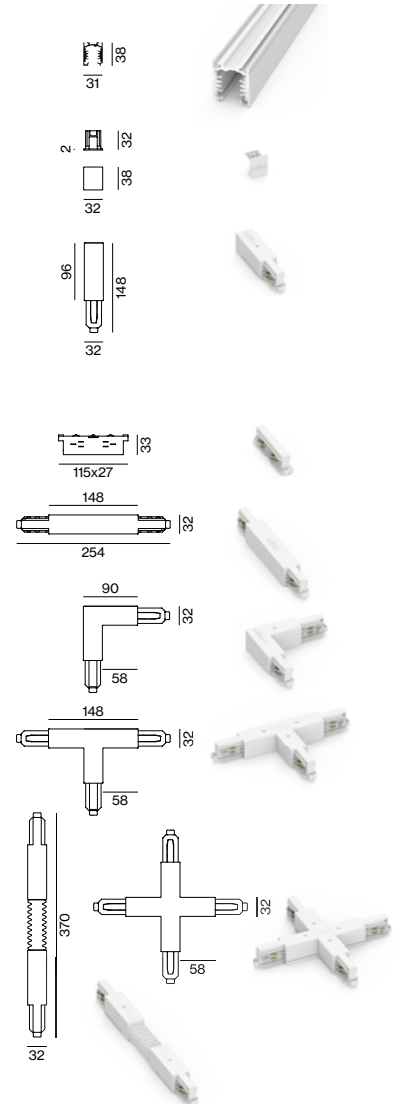

TRACK high

surface/suspended

Order options

CONTROL

non DIM

DALI-2

MATERIAL COLOUR

○ pure white RAL 9010 7

● jet black RAL 9005 8

Options on request

LIGHT OPTIC COVER

inset indirect

Pole options

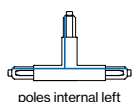

poles internal left

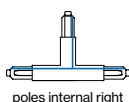

poles internal right

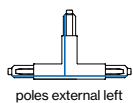

poles external left

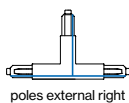

poles external right



poles end feed left



poles end feed right

TRACK high 3-phase/3-phase + DALI-2-bus



TRACK 240V-16A

L (mm)	ORDER CODE
1000	186-016113
2000	186-016213
3000	186-016313
4000	186-016413

end cap 186-026011

end feed left 186-026313

end feed right 186-026413

middle feed 186-021323

CONNECTORS 240V-16A

TYPE
linear connector 186-026113

I-connector 186-026123

L-connector right 186-026133

L-connector left 186-026233

T-connector right (poles internal) 186-026143

T-connector left (poles internal) 186-026243

T-connector right (poles external) 186-026173

T-connector left (poles external) 186-026273

X-connector 186-026153

MOUNTING ACCESSORIES

TYPE
pendant clip cable 186-0265210
pendant sheet metal clip 186-0215220
pendant clip rod 186-0265410

joiner piece cable 186-0265310

joiner piece rod 186-0265510

cutting tool 186-0219110

SUSPENSION KIT

TYPE
pendant 1000 186-0216110

cable 1500 186-0217110

cable 3000 186-0217210

cable 5000 186-0217310

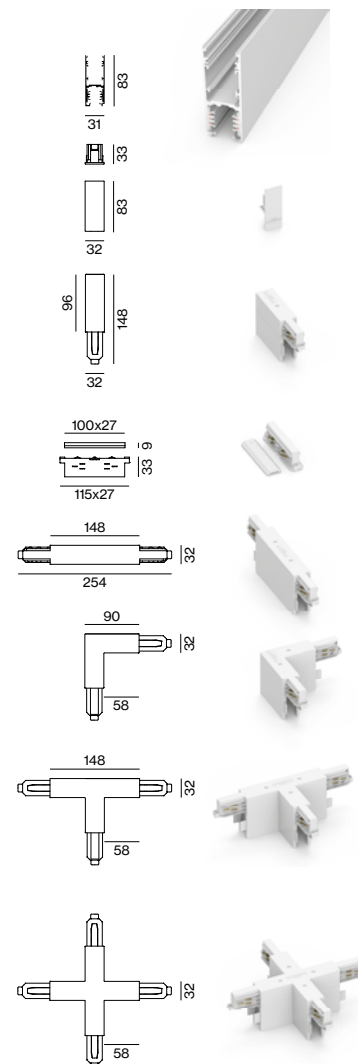

TRACK round surface/suspended

Order options

CONTROL

non DIM

DALI-2

MATERIAL COLOUR

- pure white RAL 9010 7
- jet black RAL 9005 8

Pole options

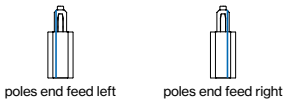
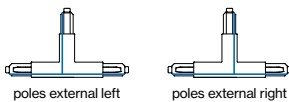
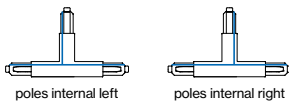

TRACK round 3-phase/3-phase + DALI-2-bus



TRACK 240V-16A

L (mm)	ORDER CODE
1000	186-015113
2000	186-015213
3000	186-015313
4000	186-015413



TRACK CURVE 240V-16A

TYPE	ORDER CODE
R 500 90° left	186-015853
R 500 90° right	186-015863

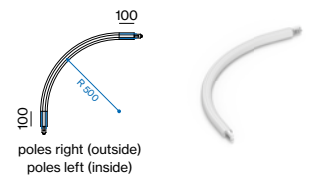

end cap	186-025011
---------	------------



end feed left	186-025313
end feed right	186-025413
middle feed	186-021323



CONNECTORS 240V-16A

TYPE	ORDER CODE
linear connector	186-021113



L-connector right (external)	186-025133
L-connector left (internal)	186-025233

T-connector left (poles external)	186-025243
T-connector right (poles external)	186-025143
T-connector right (poles internal)	186-025273
T-connector left (poles internal)	186-025173

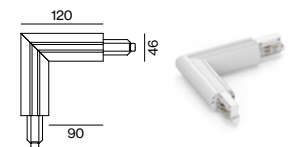

X-connector	186-025153
-------------	------------

MOUNTING ACCESSORIES

TYPE	ORDER CODE
pendant clip cable	186-025521
pendant clip rod	186-025541

joiner piece cable	186-025531
joiner piece rod	186-025551

cutting tool	186-0279110
--------------	-------------

SUSPENSION KIT

TYPE	ORDER CODE
pendant 1000	186-021611
cable 1500	186-0217110
cable 3000	186-0217210
cable 5000	186-0217310